

Surveying Tribrachs - White Paper Characteristics and Influences



- when it has to be **right**

Leica
Geosystems

March 2010

Daniel Nindl
Heerbrugg, Switzerland

Surveying tribrachs – Characteristics and Influences

Daniel Nindl

Abstract

This paper presents an overview of different factors and properties regarding surveying tribrachs. It should provide comprehensive information for the surveyor to further ensure highest quality surveys. Secondly the influences that a tribrach could be subjected to are summarized. After reading, it should be clear what the important points to think about are. Four main functions can be assigned to a tribrach:

1. connect instrument with area of support (tripod, pillars, etc.)
2. secure your instrument in the tribrach (via clamp mechanism)
3. enable the possibility to level your instrument within a certain range
4. provide a stable orientation over time

These functions are furthermore explained with detailed information.

Introduction

As a major quality measurement the meaning of hysteresis, often misunderstood, is explained and its bandwidth applied to different tribrach models. Discrete measurements confirm certain quality levels. Further aspects like special tuning of the pair instrument < > tribrach are explained as well as geometrical aspects, mechanical principles and standardized test procedures.

For genuine Leica Geosystems accessories a clear commitment to quality standards is given and Leica customers shall be sufficiently equipped with information and specifications regarding their Leica products.

Surveying tribrachs are important accessories for various applications in surveying. Widely accepted as a reliable accessory, surveyors normally do not consider the influence which its link to the ground (tribrachs & support) might have on measurements. However, obtaining a certain level of accuracy and reliability requires the consideration of all possible effects on the measurements. A high emphasis is usually put on specifications and accuracy of the total

station or other instruments. However, too often the role of accessories is not given enough thought towards the intended application and the subsequent results. Various applications require 3D coordinate qualities only in the range of centimeters. But other tasks demand much higher accuracies. For such tasks, an in-depth analysis of the influence and treatment of potential error sources is mandatory.

This paper summarizes the key factors relative to surveying tribrachs that can influence the measurements – primarily angular measurements. Centring accuracy and the tribrachs orientation in coincidence with the instruments orientation over time are two examples that may have a crucial effect on the survey results. Ignoring these key factors normally leads to a decrease of the measurement quality. All Leica Geosystems tribrachs consider these important factors. Based on sophisticated production techniques, strict assembly and quality control, Leica Geosystems ensures that Leica tribrachs are of the highest quality.

The following structure is applied to the overall document:

- Components
- Mode of operation
- Quality criteria
- User recommendations

Components & general characteristics

In general a tribrach consists of a base plate and an upper plate connected via three thread studs (cf. figure 1).

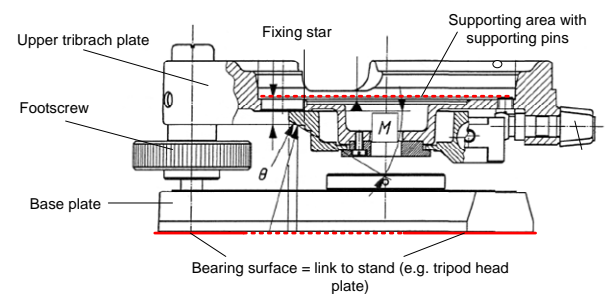

Figure 1 - Cross section of a Leica GDF121 tribrach

By turning the footscrews the upper tribach plate can be moved in relation to the base plate. By turning the footscrews differently the upper tribach plate can achieve an angle tilt (compared to the base plate) of about 10° .

A major requirement to ultimately achieve a leveled horizon for your instrument or your accessory is a horizontal plane projected through the supporting pins on the upper tribrach plate (cf. red arrows in figure 2). Ideally being parallel to the reference plane for your bubble. At least within the tolerance of the bubble specification of the circular level (e.g. Leica Geosystems' GDF121 circular bubble is specified with 8', cf. figure 4). The red lines in figure 1 indicate the upper and the lower planes on one hand providing the reference plane to the instrument, on the other hand providing the link to the supporting area of the tripod head or the measurement pillar, etc. Its planarity is an important and necessary geometrical feature to ensure the perpendicularity of the standing axis of your instrument relative to the horizon.

- **Focus Range** 0.35m to infinity
- **Centring Image** 2 concentric circles
- **Image Adjustment** adjustable

The design offers full operating ergonomics to the user to provide a convenient and fast focusing process when centering to your surveying mark. However, certain surveying tasks don't require an optical plummet, others use the instruments laser plummet, but a forced centered traverse – for instance – is hardly ever done without tribrachs having optical plummets.

Leica Geosystems accessories/tribrach portfolio offers the right model for the particular task...

Circular Level

Circular levels of Leica Geosystems tribrachs are specified with 8'/2mm (that means a tilt of the level plane of 8' moves the bubble for 2mm). The bubble is adjustable with 3 allen screws providing the possibility to make sure that the bubble remains well calibrated referring to the centrally printed circle on the bubble glass. As a reference for e.g. a tube bubble (e.g. Leica's GZR2 reflector holder) or the total station itself can be used: (1) Make sure that your instrument is calibrated, (2) use the digital bubble to level the total station – turn the instrument 180° to ensure that the digital (or analog) bubble is centered. (3) adjust the circular level of the tribrach using adjusting pin (provided either in the total station container or with the tribrach).

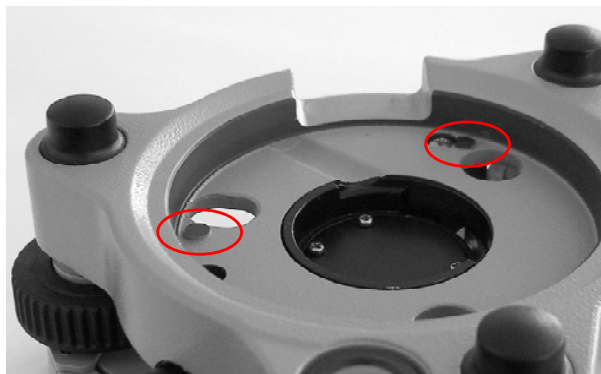

Figure 2 - Leica GDF121 tribrach showing supporting pins on upper tribrach plate

Optical Plummet

Leica Geosystems tribrach optics follow the strict Leica standards to provide a perfect, erect, crisp image, assured being distortion free.

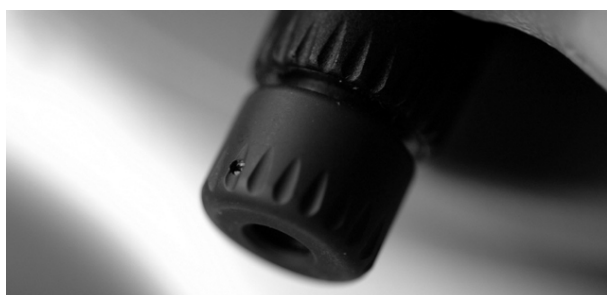

Figure 3 - Detail view of the GDF121 optical plummet

The adjustment of the plummet ocular guarantees uniform, smooth movement and no backlash. Further characteristics are:

- **Magnification** 2x
- **Field of view** 6° +-1°
- **Eyepiece Adjustment range:** ±5 dioptries
- **Centring Accuracy** ±0.5mm@1.5m



Figure 4 - Detail view of the GDF121 circular bubble

Supporting Areas / Supporting Pins

The mechanical design and the treatment (especially hardened) of the surfaces of the supporting areas is also a fundamental characteristic to create a solid,

anti-slippery connection to the tripod head plate (cf. figure 2 and figure 5).



Figure 5 - Bottom side of the base plate of a Leica GDF121 tribrach – shown is one of three supporting areas (points)

Historical Design Aspects

In figure 6 a former Leica (Wild) tribrach model is shown – the GDF6 (not available any more), used as standard tribrach for various instruments (e.g. Wild T16). The cut (1) in figure 6 was used to fix the instrument permanently in the same position in the tribrachs (older instruments had a compatible nose) to avoid centring errors for special applications. The hole (2) was made for the light channel for the horizontal circle reading. Today's models do not provide the hole (2) any more because it's simply outdated. There are no devices relying on it any more. However, the cut (1) is still necessary for some instruments (e.g. Leica TDA5100).

Soon after market introduction first sub-standard copies appeared and various manufacturers still produce models having these holes without knowing why...

Leica Geosystems' tribrachs remain compatible in order to provide a flexible and efficient use of your equipment.



Figure 6 - Detail view of WILD GDF6 tribrach

Mode of Operation

Even though a tribrach appears to be a simple connecting device between the instrument and its support, the mechanics behind have to be designed sophisticatedly in order to guarantee smooth operation over its entire lifecycle. To secure your instrument in the tribrach is one of its four major tasks. Therefore the clamping arm (G) is turned (close/open) to press the clamping flange of the lock assembly (E) into the instruments holding studs (A).

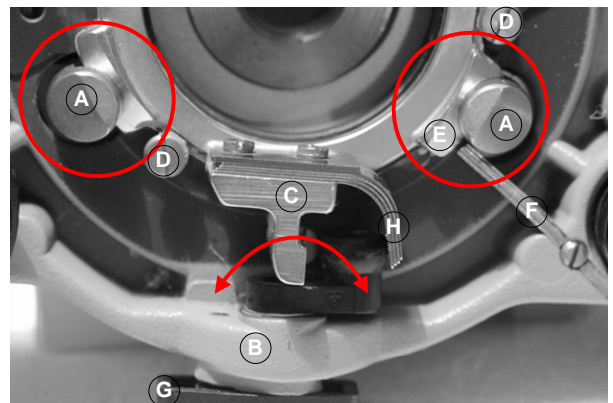

Figure 7 - Detail view (from below) of the upper tribrach plate showing the instrument secured

- | | |
|---|---|
| A | instrument studs |
| B | upper tribrach plate |
| C | lock assembly – spring holder |
| D | holding screws for lock assembly – in other models also realized through an insert ring |
| E | lock assembly – clamping flange |
| F | orientation spring |
| G | tribrach clamping arm |
| H | lock assembly - spring |

Before the clamping mechanism can work, the instrument needs to be placed in the tribrach. Sounds easy, but the initial position of the instrument studs – cf. figure 8 is arbitrary. If the clamp is released, the orientation spring is loose.

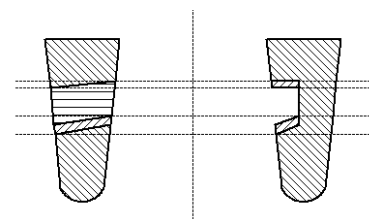

Figure 8 - Cross section of instrument studs

When tightening the clamp, the stud in hole 1 (cf. figure 9) is pressed to its edge via the orientation

spring. Further the lock assembly ring is turned slightly eccentric because of non-concentric position of the clamping arm.

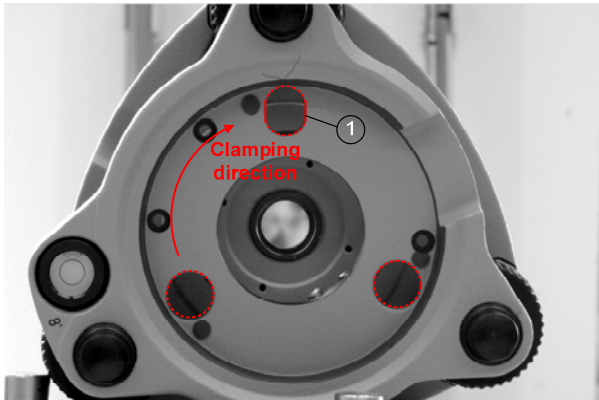

Figure 9 - View of the upper tribrach plate showing the holes for the instrument studs and indicating the clamping direction

Based on the special design of the clamping flanges E (cf. figure 10b) together with the tilted cut of the instrument studs a buildup of pressure occurs when closing the clamp. Subsequently the lock assembly (fixing star) presses the instrument studs against the upper tribrach plate. Now the instrument is secure.

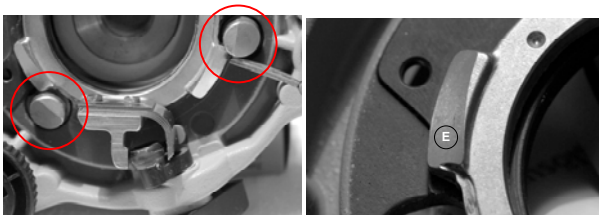

Figure 10a+b - Detail view (from below) of the upper tribrach plate showing the instrument released (a); Detail view of a clamping flange (b)

Especially the clamping flange E (cf. figure 10b) is a very sensitive part in order to guarantee a perfect clamping function.

For Leica Geosystems tribrachs, the design, the manufacturing process and the quality control of the lock assembly ring follows traditional high standards in order to guarantee smooth operation and long lifetime.

Quality Criteria

Certain tribrach features are defined with an ISO standard to establish general standards for different manufacturers. Furthermore interchangeability between instruments shall be guaranteed. Beside mechanical design elements, one of the major accuracy

measurements (= torsional rigidity) is defined in the following standard:

ISO Standard 12858-3

Torsional Rigidity (Hysteresis)

"The tribrach shall be capable of absorbing, without lasting deformation, the torsion which occurs when the instrument is used." [ISO12858-3]

The statement above refers to the second main function: secure your instrument in the tribrach – over the entire measuring process! It's important to rely on the initial orientation of the tribrach to achieve accurate horizontal (and vertical) angle measurements to subsequently guarantee the instruments overall orientation.

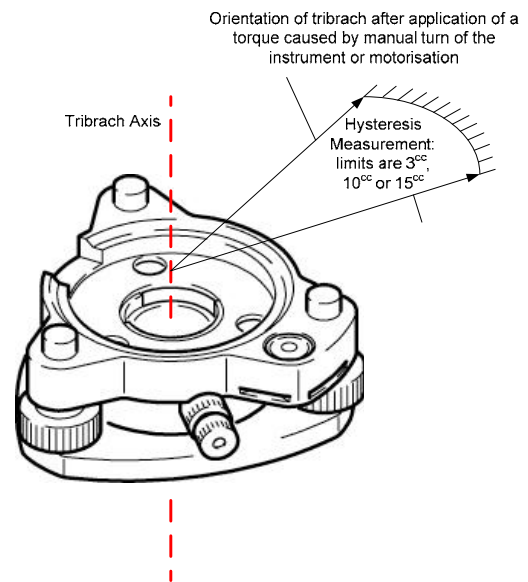

Figure 11 - Illustration of the meaning of hysteresis

In both cases, when using a motorized or a manual instrument, certain torques are applied from the instrument to the tribrach, then furthermore to the tripod (or any other support) and subsequently to the ground.

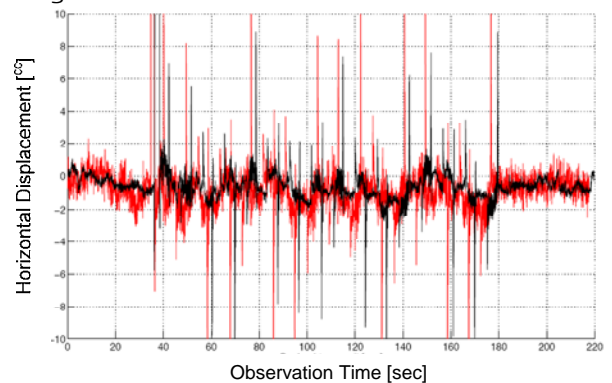

Figure 12 - Effect of applied torques to tribrach and tripods

Figure 12 shows a synchronized measurement of torsional rigidity of a tribrach (red line). The damping (partly absorption of applied torque) shall be indicated; compared to the black line (measurement at tripod head) the red line shows continuously higher amplitudes – this is a clear evidence for the absorption characteristics of tripods. The measurement series shown in figure 2 was performed with a Leica TCA2003 (7.5 kg) executing an automated measurement sequence to 2 prisms in two faces during a measurement time of ca. 4min. During these face changes high torque-peaks are created (up to $20^{\circ}=7''$). This is acceptable as long as the deformation is elastic and the initial orientation is held within a certain level (compare average deformation level within measurements 0-20 and 200-220). The according hysteresis is less than $1^{\circ}=0.3''$. Further information regarding hysteresis measurements is shown in Kusber, 2007.

The according ISO standard doesn't define any limits regarding torsional rigidity, derived from hysteresis measurements it is just mentioned that: *"It shall be the responsibility of the user to ensure that the tribrach has sufficient torsional rigidity to be compatible with the accuracy of the instrument"* [ISO12858-3]

Subsequently the orientation of the instrument in Leica Geosystems tribrachs during and after use refers to certain limits. Leica Geosystems' tribrachs portfolio offers 3 main series:

- Professional 1000: < 15° (5")
- Professional 3000: < 10° (3")
- Professional 5000: < 3° (1")

These values are under continuous quality control within Leica Geosystems quality management. Thereby total compliance of technical specification is ensured. Operators can fully trust Leica Geosystems! And with a broad product portfolio, a tribrach can be found for all applications.

Life Time Tests

Every instrument setup must undergo a leveling process in order to guarantee the operation of your compensator and to refer your measurement to the horizon respectively. The remaining tilt after your tripod setup is usually compensated via your tribrach footscrews. Leica Geosystems tribrachs are tested with 3000 turns on each screw over the entire length of the thread.

Over 3000 turns for each screw Leica Geosystems ensures

- a smooth and friction-free movement
- without any backlash and
- no grating.

In figure 13 a detail of Leica Geosystems lifetime test machine is shown.



Figure 13 - Tribrach lifetime test setup

User Recommendations

Almost every total station, GNSS antenna, laser scanner or laser plummet is mounted and secured with a tribrach (some examples are shown in figure 14); through the forced centring system the setup of the particular device over a given control point becomes possible. Tribrachs are an integral part of surveying procedures, and careful selection is critical to ensure the required accuracy is achieved.

Devices on the Tribrach



Figure 14 - Different devices requiring a tribrach in order to be used at all

Special applications like forced traverses cannot be performed without using a forced centring system provided by tribrachs. Other applications based on

pillar setups are not possible without using tribrachs either...

Within Leica Geosystems entire instrument portfolio it is warranted that all tribrach models are designed to fit to particular instruments and devices. The mechanical design, the environmental standards and the accuracy specifications are aligned to enable a maximum of flexibility within your Leica hardware.

Genuine Leica vs. Leica Copies

Various tribrachs copies are available on the market. To rigorously compare genuine Leica tribrachs with products cheaply copied is not easy. The devil is in the detail. An objective measurement is certainly a determination of the torsional rigidity via hysteresis measurements, but this takes time and is most likely not easily possible for most users. A low quality copy may look the same, but will certainly not satisfy surveyors expectations. However, over time the thread-wear and the loose of clamping mechanism will be certainly noticeable whereas the genuine Leica tribrachs guarantee continued quality.

Turning the screws, turning the focus ring of the optical plummet, closing the clamp: a genuine Leica product guarantees smooth operation – the operator certainly feels the difference! Along the same side a smooth functioning is the basis for a long life of your product.

What you get is a „Black-Box“ purchase. Something that looks similar as a genuine Leica accessory but ultimately you just don't know what you have got ...

Supplier qualification for a sustainable product quality
Material and process qualification
Casting metal
Planarity of supporting points - lower tribrach plate
Planarity of supporting points - upper tribrach plate
Torsional Rigidity
Tribrach clamp
Tribrach screws
Monitor assembly process
Fulfill national testings and regulations
Requalification of technical specification in certain intervals
Finetuning of tribrach to the instruments for maximum torsional rigidity and lifetime.

Figure 15 - Quality management steps within Leica Geosystems' tribrachs assembly

Figure 15 represents the necessary steps to manufacture a genuine Leica Geosystems tribrach. Most of the steps are invisible to the customers, but in compliance with our strong quality we guarantee to supply the best products for our customers.

Best Practice

The goal of this paper is to provide surveyors with basic knowledge of the less thought about details which a measurement-setup consists of – in particular the role of the tribrachs. And for the surveyors who strive for the most precise measurement, this paper provides a strong summary for both the magnitude and effects of the chosen target components that influence the measurements:

To achieve highest measurement accuracy

- Use tribrachs with adequate specifications in order to fulfill required measurement accuracy
- Use a tribrach model providing required features (e.g. optical plummet)
- Ensure periodic maintenance

Table 1 shows a summary of different tribrach models, currently offered within Leica Geosystems accessories portfolio.

Model	Torsional Rigidity	Optical Plummet	Operating life	Weight	Colour
GDF121	3cc	NO	3000	780g	GREEN
GDF122	3cc	YES	3000	860g	GREEN
GDF111-1	10cc	NO	3000	780g	GREEN
GDF112	10cc	YES	3000	860	GREEN/ RED
GDF101	15cc	NO	1000	780g	BLACK
GDF102	15cc	YES	1000	860g	BLACK

Table 1 - Different tribrachs models with its main characteristics

The benefits when using Leica Geosystems surveying tribrachs are long lifetime, highest accuracy and highest reliability. Leica Geosystems accessories are adjusted together with Leica Geosystems instruments. Thus we can guarantee best performance and quality of your measurements.

References

[ISO1723-3]

ISO 12858-3:2005(E) – INTERNATIONAL STANDARD „Optics and optical instruments – Ancillary devices for geodetic instruments – Part 3: Tribrachs, ISO 2005”, www.iso.org

[DIN2277]

DIN 2277 – DEUTSCHE NORMEN „Dosenlibellen – Begriffe und Ausführungen” , 1961

[Kusber07]

KUSBER, Danuta: Accuracy Analysis of a 0.5” Total-station in Relation to the Centre of Gravity Offset and Tribrach Deformations – Diploma Thesis, University of Applied Sciences Mainz

Whether you want to monitor a bridge or a volcano, survey a skyscraper or a tunnel, stake out a construction site or perform control measurements – you need reliable equipment. With Leica Geosystems original accessories, you can tackle demanding tasks. Our accessories ensure that the specifications of the Leica Geosystems instruments are met. Therefore you can rely on their accuracy, quality and long life. They ensure precise and reliable measurements and that you get the most from your Leica Geosystems instrument.

When it has to be right.

Illustrations, descriptions and technical specifications are not binding and may change.
Printed in Switzerland – Copyright Leica Geosystems AG, Heerbrugg, Switzerland, 2010.
VII.10 – INT

Leica Geosystems AG
Heerbrugg, Switzerland

www.leica-geosystems.com

- when it has to be **right**

Leica
Geosystems